

M8

Representación Gráfica en Maquinaria

Curso: 1º C. F. Grado Superior
Mantenimiento Equipo Industrial

**- VISTAS NECESARIAS
(SOLUCIONES 1-9)**

Profesor: Luis Lavilla



Vistas necesarias. SOLUCIONES 1

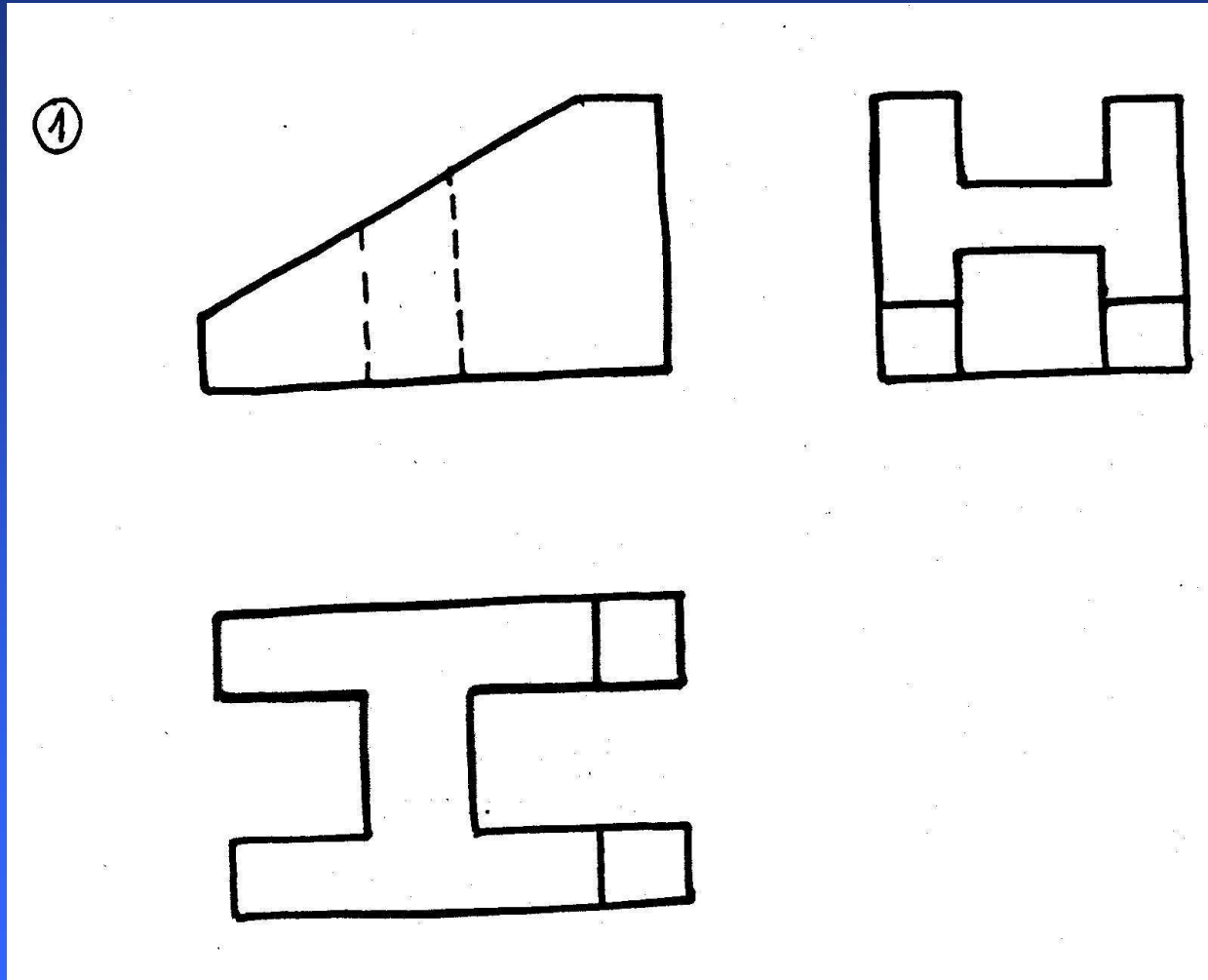
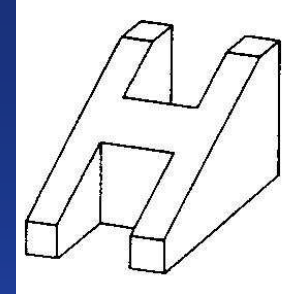

Vistas necesarias. SOLUCIONES 2

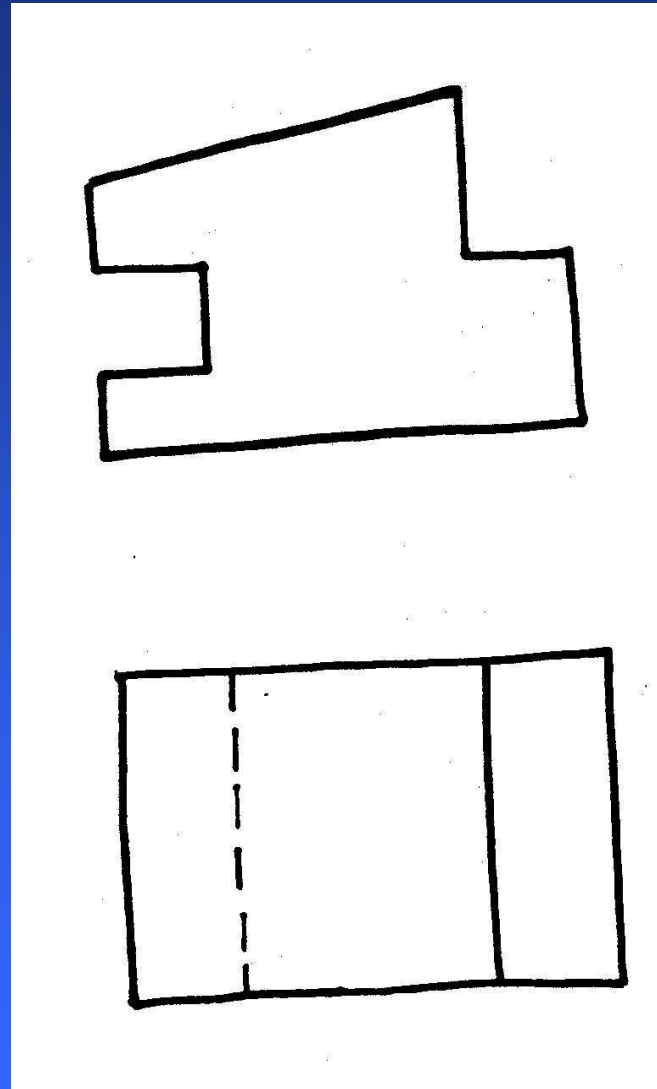
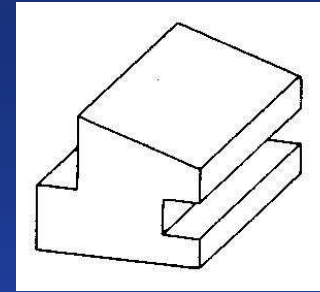

Vistas necesarias. SOLUCIONES 3

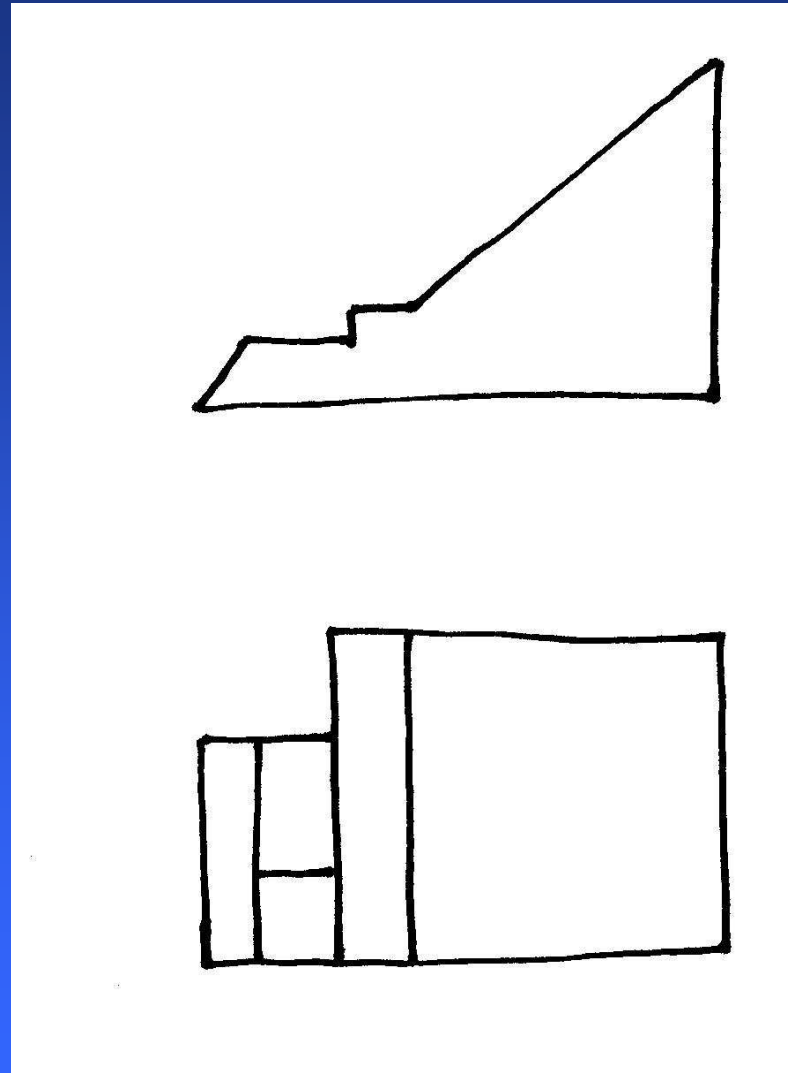
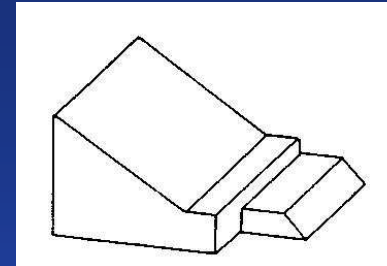

Vistas necesarias. SOLUCIONES 4

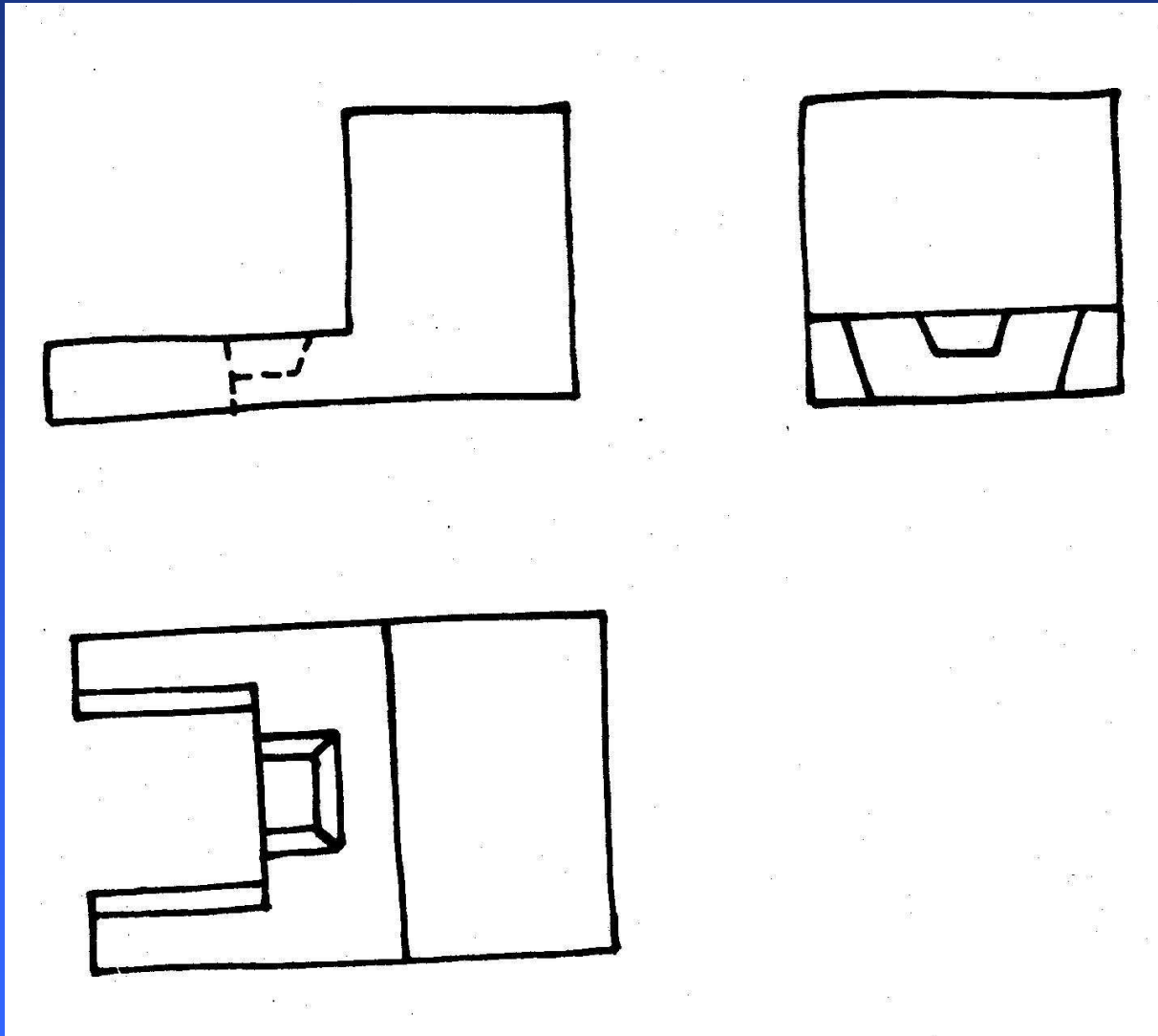
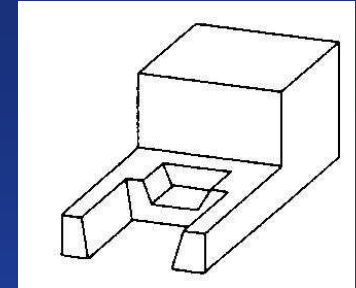

Vistas necesarias. SOLUCIONES 5

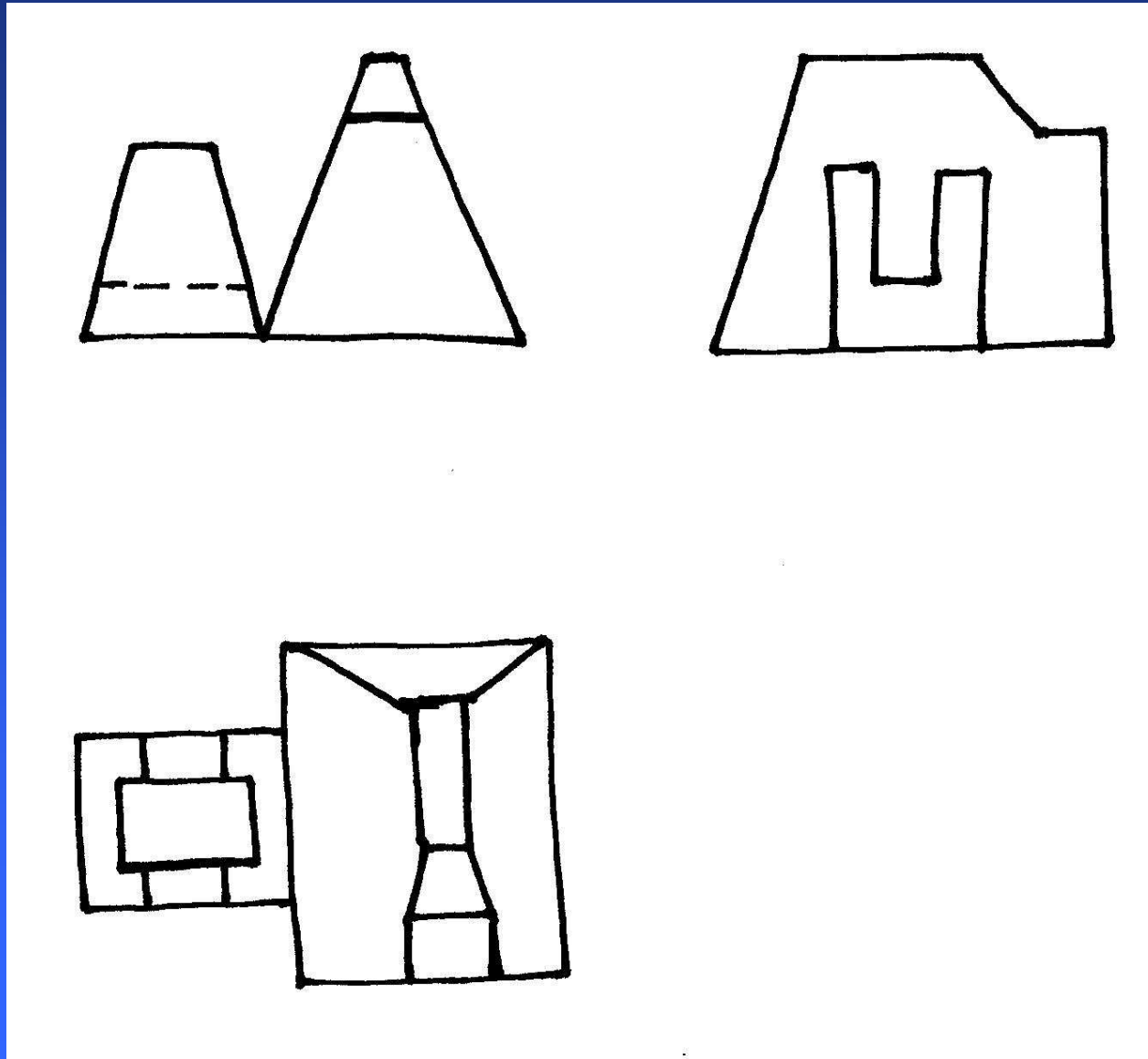
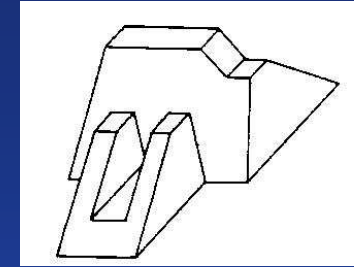

Vistas necesarias. SOLUCIONES 6

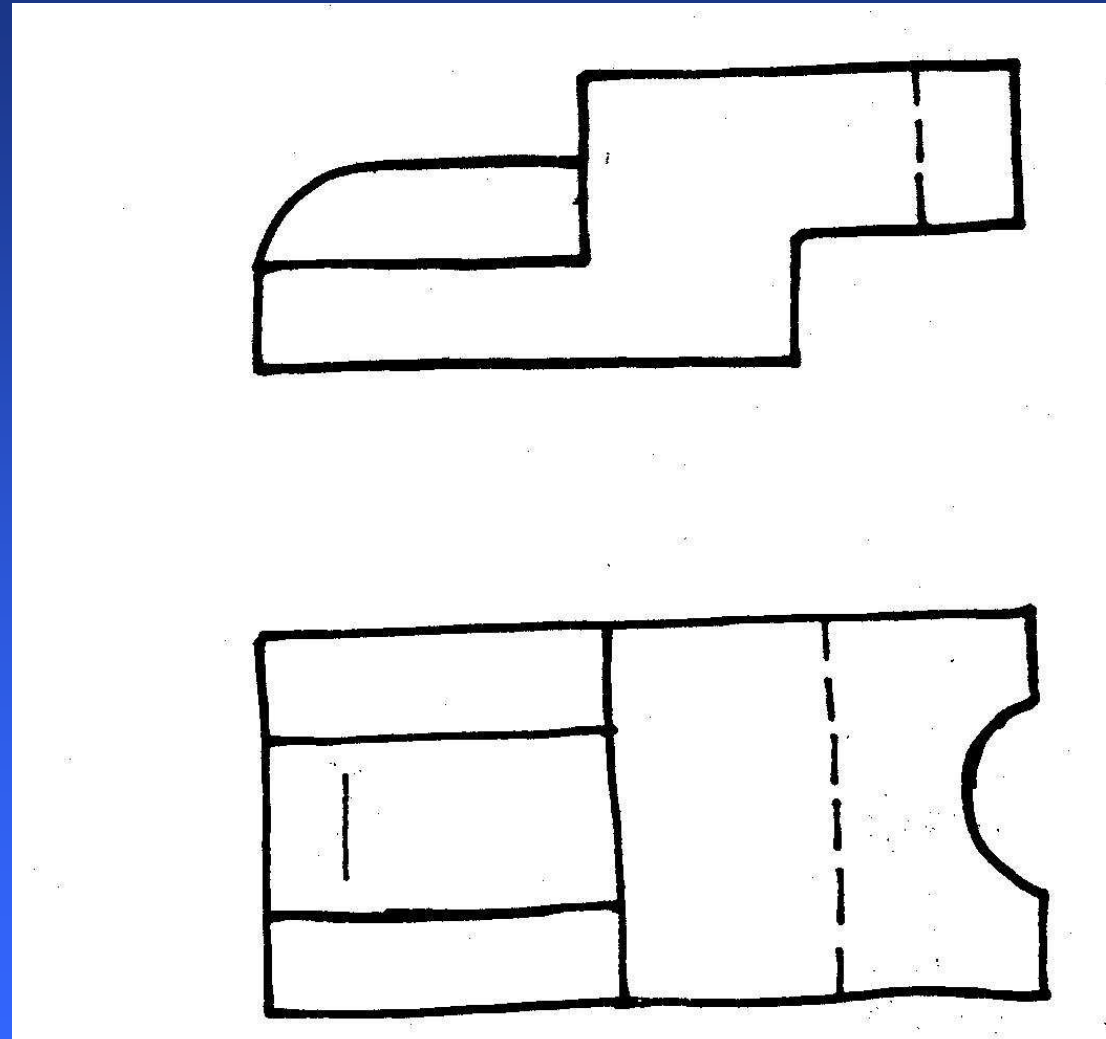
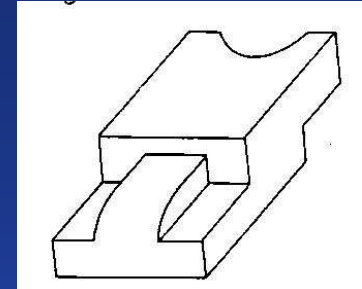

Vistas necesarias. SOLUCIONES 7

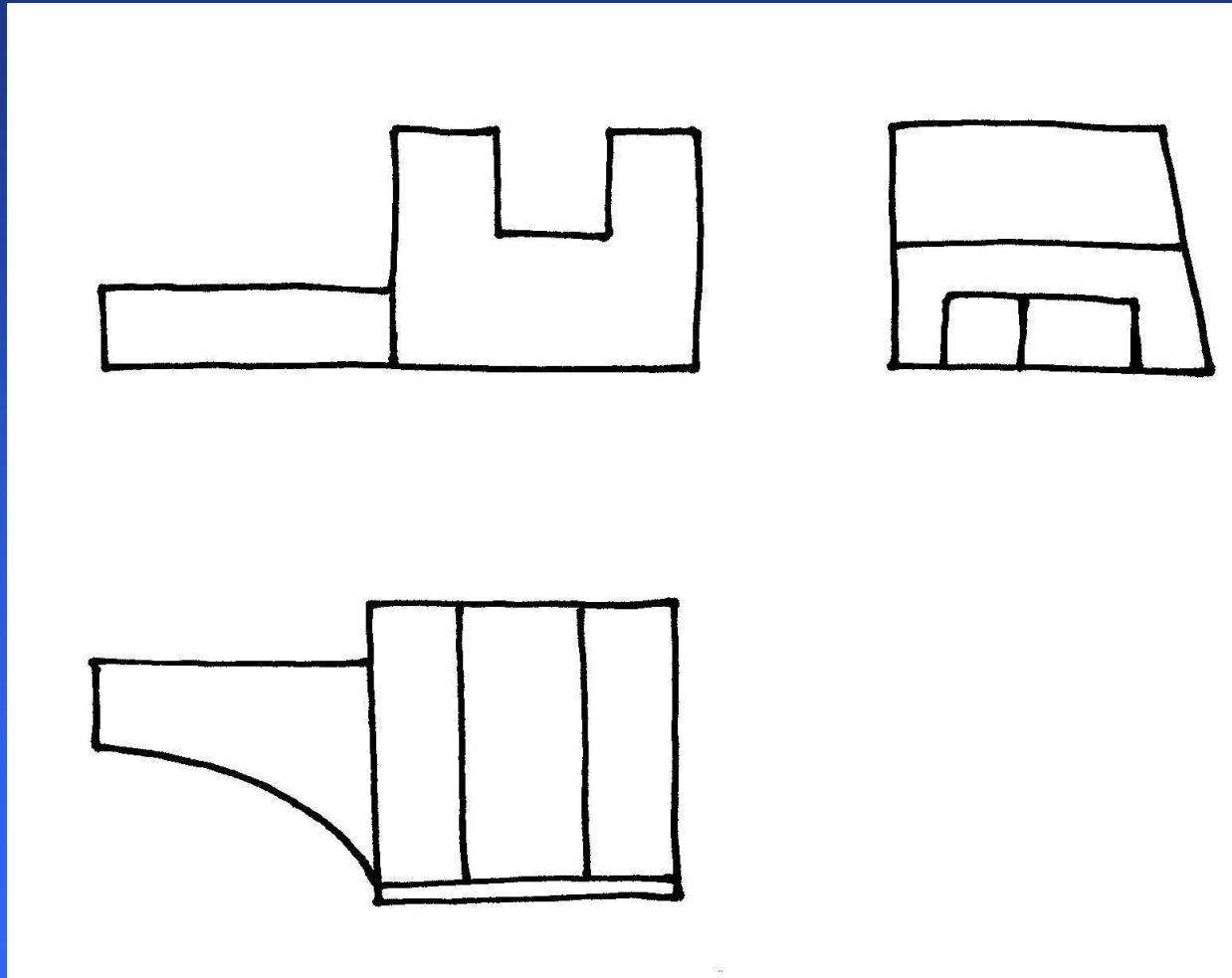
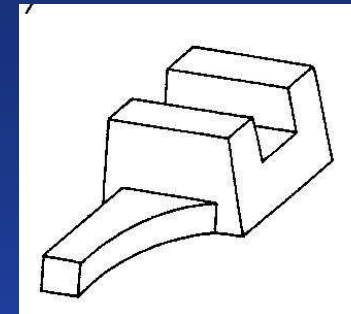

Vistas necesarias. SOLUCIONES 8

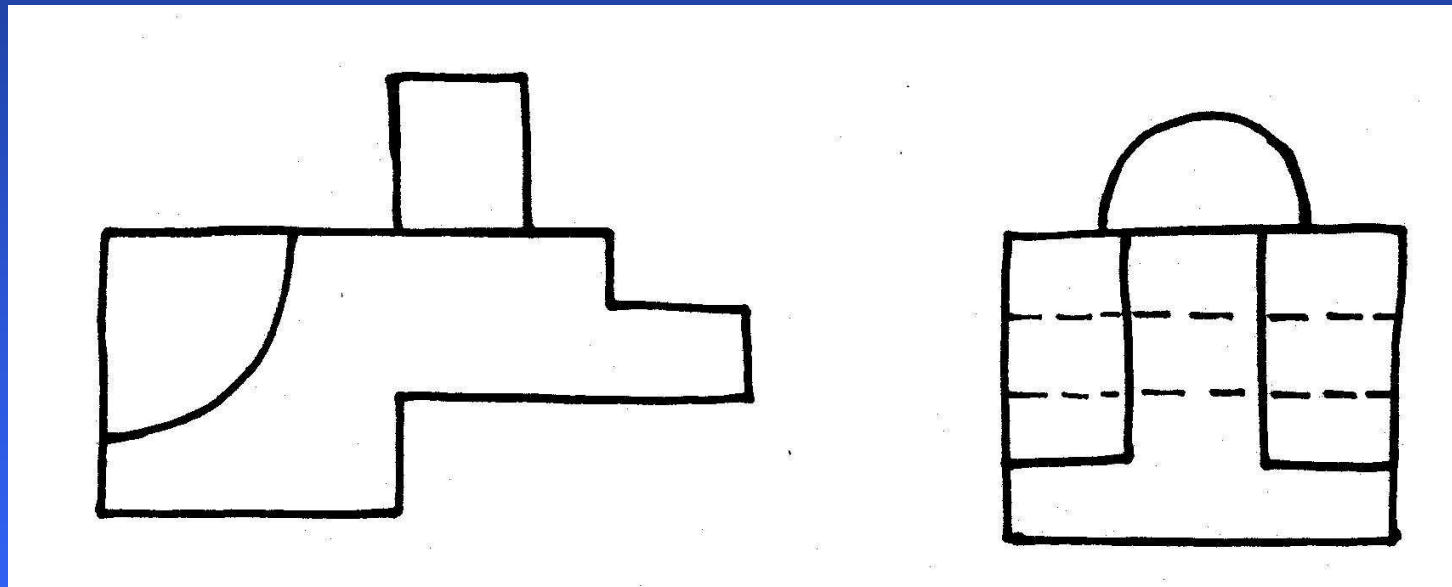
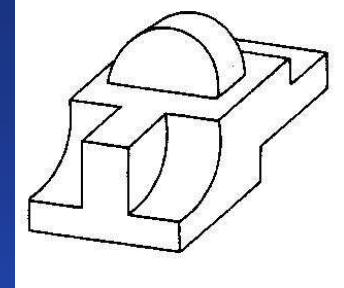

Vistas necesarias. SOLUCIONES 9

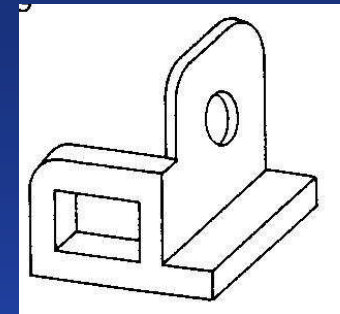
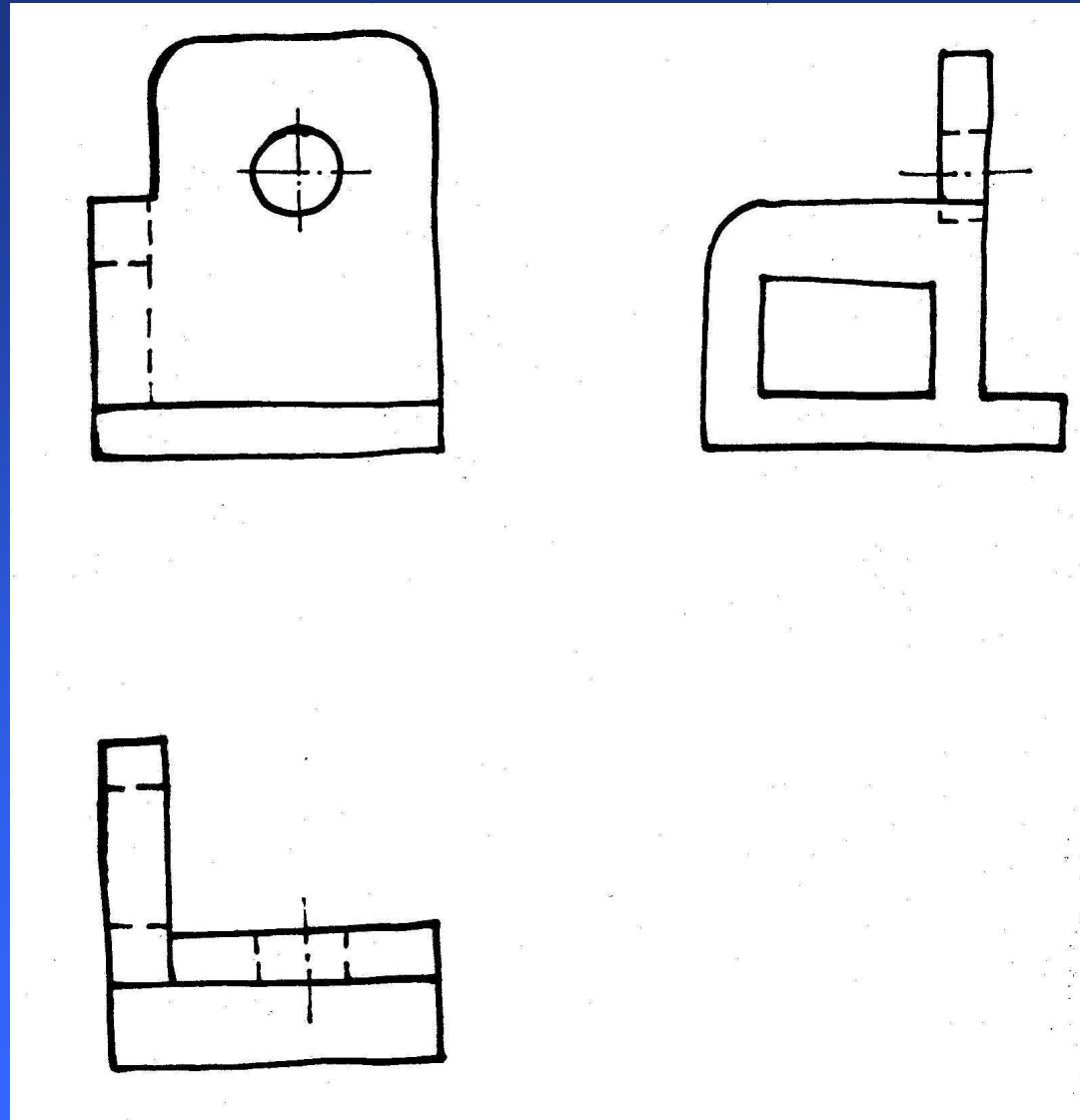

Fin

Profesor: Luis Lavilla
Redrado.

