

User Guide
6619-2202

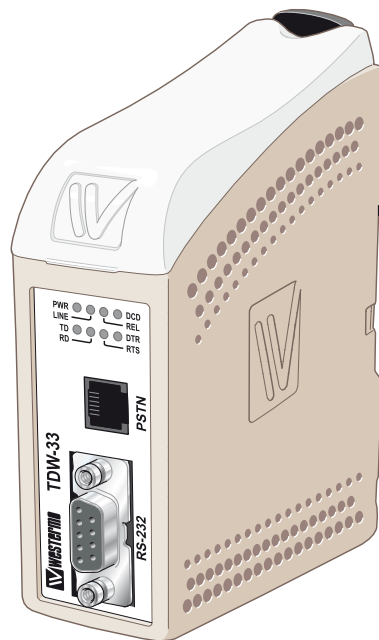

TDW-33



DIN-rail
Tele V.90 modem

www.westermo.com

Legal information

The contents of this document are provided “as is”. Except as required by applicable law, no warranties of any kind, either express or implied, including, but not limited to, the implied warranties of merchantability and fitness for a particular purpose, are made in relation to the accuracy and reliability or contents of this document. Westermo reserves the right to revise this document or withdraw it at any time without prior notice.

Under no circumstances shall Westermo be responsible for any loss of data or income or any special, incidental, and consequential or indirect damages howsoever caused.

More information about Westermo can be found at the following Internet address:

<http://www.westermo.com>

Safety



Before installation:

This modem is for restricted access area use only.

Read this manual completely and gather all information on the unit. Make sure that you understand it fully. Check that your application does not exceed the safe operating specifications for this unit.

This unit should only be installed by qualified personnel.

This unit should be built-in to an apparatus cabinet, or similar, where access is restricted to service personnel only.

The power supply wiring must be sufficiently fused, and if necessary it must be possible to disconnect manually from the power supply. Ensure compliance to national installation regulations.

Maximum 20 A branch circuit protection required.

The product is intended to work with IT power system.



This unit uses convection cooling. To avoid obstructing the airflow around the unit, follow the spacing recommendations (see Cooling section).

Before mounting, using or removing this unit:

Prevent access to hazardous voltage by disconnecting the unit from power supply.

Warning! Do not open connected unit. Hazardous voltage may occur within this unit when connected to power supply or TNV circuits.

Care recommendations

Follow the care recommendations below to maintain full operation of unit and to fulfil the warranty obligations.

This unit must not be operating with removed covers or lids.

Do not attempt to disassemble the unit. There are no user serviceable parts inside.

Do not drop, knock or shake the unit, rough handling above the specification may cause damage to internal circuit boards.

Do not use harsh chemicals, cleaning solvents or strong detergents to clean the unit.

Do not paint the unit. Paint can clog the unit and prevent proper operation.

Do not expose the unit to any kind of liquids (rain, beverages, etc). The unit is not waterproof. Keep the unit within the specified humidity levels.

Do not use or store the unit in dusty, dirty areas, connectors as well as other mechanical part may be damaged.

If the unit is not working properly, contact the place of purchase, nearest Westermo distributor office or Westermo Tech support.

Maintenance

No maintenance is required, as long as the unit is used as intended within the specified conditions.

The unit interior doesn't contain any user settable items, all configuration is performed via the DTE interface with AT-commands.

Agency approvals and standards compliance

Type	Approval / Compliance
EMC	EN 61000-6-2, Immunity industrial environm
	EN 55024, Immunity IT equipment
	EN 61000-6-3, Emission residential environments
	FCC part 15 Class B
	EN 50121-4, Railway signalling and telecommunications apparatus
	IEC 62236-4, Railway signalling and telecommunications apparatus
Safety	EN 60950-1 and UL 60950-1, IT equipment
PSTN	CS 03 Part 1, issue 9 FCC part 68, TIA-968-A ETSI TS103 021-1, ETSI TS103 021-2, ETSI TS103 021-3 AS/ACIF S002, AS/ACIF S006

According to: **TIA-968-A and CS-03 Part 1, issue 9**

This equipment complies with Part 68 of the FCC rules and the requirements adopted by the ACTA. On the left side of this equipment is a label that contains, among other information, a product identifier in the format US:AAAEQ##TXXXX. If requested, this number must be provided to the telephone company.

A plug and jack used to connect this equipment to the premises wiring and telephone network must comply with the applicable FCC Part 68 rules and requirements adopted by the ACTA. A compliant telephone cord and modular plug is provided with this product. It is designed to be connected to a compatible modular jack that is also compliant. See installation instructions for details.

Caution-to reduce the risk of fire, use only No.26 AWG or larger telecommunication cable.

The USOC jack required RJ11-C, and the REN is used to determine the number of devices that may be connected to a telephone line. Excessive RENs on a telephone line may result in the devices not ringing in response to an incoming call. In most but not all areas, the sum of RENs should not exceed five (5.0). To be certain of the number of devices that may be connected to a line, as determined by the total RENs, contact the local telephone company. For products approved after July 23, 2001, the REN for this product is part of the product identifier that has the format US:AAAEQ##TXXXX. The digits represented by ## are the REN without a decimal point (e.g., 03 is a REN of 0.3). For earlier products, the REN is separately shown on the label.

If this equipment TDW-33 causes harm to the telephone network, the telephone company will notify you in advance that temporary discontinuance of service may be required. But if advance notice isn't practical, the telephone company will notify the customer as soon as possible. Also, you will be advised of your right to file a complaint with the FCC if you believe it is necessary.

The telephone company may make changes in its facilities, equipment, operations or procedures that could affect the operation of the equipment. If this happens the telephone company will provide advance notice in order for you to make necessary modifications to maintain uninterrupted service.

If trouble is experienced with this equipment TDW-33, for repair or warranty information, please contact Westermo Data Communication, Inc. 11200 Westheimer, Suit 900. Houston, TX, 77042. Phone number: 713-240-0367. If the equipment is causing harm to the telephone network, the telephone company may request that you disconnect the equipment until the problem is resolved. There are no repairs the customer/user can perform inside the modem.

In the event of equipment malfunction, all repairs should be performed by our Company or an authorized agent. It is the responsibility of users requiring service to report the need for service to our Company or to one of our authorized agents. Service can be facilitated through our office at:

Westermo Data Communication Inc

11200 Westheimer Suit 900
Houston, TX, 77042
TEL: 713-240-0367

Connection to party line service is subject to state tariffs. Contact the state public utility commission, public service commission or corporation commission for information.

If your home has specially wired alarm equipment connected to the telephone line, ensure the installation of this TDW-33 does not disable your alarm equipment. If you have questions about what will disable alarm equipment, consult your telephone company or a qualified installer.

Electrical Safety Advisory:

Parties responsible for equipment requiring AC power should consider including an advisory notice in their customer information suggesting the customer use a surge arrester. Telephone companies report that electrical surges, typically lightning transients, are very destructive to customer terminal equipment connected to AC power sources. This has been identified as a major nationwide problem.

Declaration of Conformity



Westermo Teleindustri AB

Declaration of conformity

The manufacturer Westermo Teleindustri AB
SE-640 40 Stora Sundby, Sweden

Herewith declares that the product(s)

Type of product	Model	Art no	Installation manual
DIN-rail Tele modem	TDW-33	3619-0001	6619-2201

is in conformity with the following EC directive(s).

No	Short name
89/336/EEG	Electromagnetic Compatibility (EMC)
73/23/EEG	Low Voltage Directive - LVD

References of standards applied for this EC declaration of conformity.

No	Title	Issue
EN 61000-6-2	Immunity for industrial environments	2 (2001)
EN 55024	Information technology equipment – Immunity	1 (1998)
EN 61000-6-3	Emission standard for industrial environments	1 (2001)
EN 60950	Safety of information technology equipment	6 (2000)
EN 50121-4	Railway signalling and telecommunications apparatus	
IEC 62236-4	Railway signalling and telecommunications apparatus	
UL 60950-1	Safety – Part 1: General Requirements	1 (2007-07-07)
CSA C22.2 60950-1-03	Safety – Part 1: General Requirements	1 (2006-07)
FCC Part 68	Terminal Equipment to Telephone Network according to TIA-968-A and CS-03 Part 1, Issue 9	(2006-11-03)

The last two digits of the year in which the CE marking was affixed: 06

Herewith declares that product(s) listed above is in conformity with

No	Title	Issue
FCC part 15	Radio frequency devices	



Signature

Pierre Öberg
Technical Manager
26 of May 2008

Postadress/Postal address	Tel.	Telefax	Postgiro	Bankgiro	Org.nr/ Corp. identity number	Registered office
S-640 40 Stora Sundby Sweden	016-428000 Int+46 16428000	016-428001 Int+46 16428001	52 72 79-4	5671-5550	556361-2604	Eskilstuna

Type tests and environmental conditions

Electromagnetic Compatibility			
Phenomena	Test	Description	Test levels
ESD	EN 61000-4-2	Enclosure contact	± 6 kV
		Enclosure air	± 8 kV
RF field AM modulated	IEC 61000-4-3	Enclosure	20 V/m 80% AM (1 kHz), 80 – 2000 MHz
RF field 900 MHz	ENV 50204	Enclosure	20 V/m pulse modulated 200 Hz, 900 ± 5 MHz
Fast transient	EN 61000-4-4	Signal ports	± 2 kV
		Power ports	± 2 kV
Surge	EN 61000-4-5	Signal ports unbalanced	± 2 kV line to earth, ± 2 kV line to line
		Signal ports balanced	± 2 kV line to earth, ± 1 kV line to line
		Power ports	± 2 kV line to earth, ± 2 kV line to line
RF conducted	EN 61000-4-6	Signal ports	10 V 80% AM (1 kHz), 0.15 – 80 MHz
		Power ports	10 V 80% AM (1 kHz), 0.15 – 80 MHz
Power frequency magnetic field	EN 61000-4-8	Enclosure	100 A/m, 50 Hz, 16.7 Hz & 0 Hz
Pulse magnetic field	EN 61000-4-9	Enclosure	300 A/m, 6.4 / 16 µs pulse
Voltage dips and interruption	EN 61000-4-11	AC power ports	10 & 5 000 ms, interruption 10 & 500 ms, 30% reduction 100 & 1 000 ms, 60% reduction
Mains freq. 50 Hz	EN 61000-4-16	Signal ports	100 V 50 Hz line to earth
Mains freq. 50 Hz	SS 436 15 03	Signal ports	250 V 50 Hz line to line
Voltage dips and interruption	EN 61000-4-29	DC power ports	10 & 100 ms, interruption 10 ms, 30% reduction 10 ms, 60% reduction +20% above & -20% below rated voltage
Radiated emission	EN 55022	Enclosure	Class B
	FCC part 15		Class B
Conducted emission	EN 55022	AC power ports	Class B
	FCC part 15	AC power ports	Class B
	EN 55022	DC power ports	Class B
Dielectric strength	EN 60950	Signal port to other isolated ports	2 kVrms 50 Hz 1 min
		Power port to other isolated ports	3 kVrms 50 Hz 1 min 2 kVrms 50 Hz 1 min (@ rated power <60 V)
Environmental			
Temperature		Operating	-25 to +70°C
		Storage & Transport	-40 to +70°C
Humidity		Operating	5 to 95% relative humidity non condensing
		Storage & Transport	5 to 95% relative humidity non condensing
Altitude		Operating	2 000 m / 70 kPa
Reliability prediction (MTBF)	MIL-HDBK-217F	Operating	
Service life		Operating	10 year
Vibration	IEC 60068-2-6	Operating	7.5 mm, 5 – 8 Hz 2 g, 8 – 500 Hz
Shock	IEC 60068-2-27	Operating	15 g, 11 ms
Packaging			
Enclosure	UL 94	PC / ABS	Flammability class V-1
Dimension W x H x D			35 x 121 x 119 mm
Weight			0.21 kg
Degree of protection	IEC 529	Enclosure	IP 21
Cooling			Convection
Mounting			Horizontal on 35 mm DIN-rail

Description

The TDW-33 is designed to function reliably within industrial environments and in areas of high level interference. The modem has an RS-232 interface supporting terminal data rates up to 115 kbit/s.

The TDW-33 is a V.90 modem meaning that it can support data rates of up to 56 kbit/s on the PSTN line side.

The modem is equipped with transient protection on the line side and a “watchdog” that monitors and automatically resets the modem in the event of a fault. These functions together with remote configuration make the modem perfect for installation at unmanned sites and prevent the need of costly service trips.

The modem also has password protection, dial-back security and caller ID answering to ensure that only authorised users can communicate with the modem and any connected equipment.

The TDW-33 is ideal for industrial applications as it mounts easily on to a 35 mm DIN-rail, runs from 12–36 VDC power supplies, has screw terminal connections and is tri galvanically isolated.

For ease of setup the modem is supported by the Westermo TD-tool configuration software. Drivers for Windows setup are also supplied.

- ⌘ Extended temperature range -25°C to $+70^{\circ}\text{C}$
- ⌘ Data rate up to 56 kbit/s (V.90)
- ⌘ Terminal rate up to 115.2 kbit/s
- ⌘ DTR and incoming data dialling
- ⌘ Watchdog
- ⌘ Secure call back and access
- ⌘ Industrial environment transient protection on all interfaces
- ⌘ Up to 11 data bits
- ⌘ Tri-Galvanic isolation (interface/line/supply)
- ⌘ Caller ID presentation and answering
- ⌘ Remote configuration

Interface specifications

Power LV	
Rated voltage	12 to 48 VDC or 12 to 34 VAC
Operating voltage	10 to 60 VDC or 10 to 42 VAC
Rated current	150 mA @ 12 VDC 70 mA @ 24 VDC 40 mA @ 48 VDC 150 mA @ 12 VAC 70 mA @ 24 VAC
Rated frequency	DC: – AC: 48 – 62 Hz
Inrush current I ² t	0.25 A ² s
Startup current*	0.30 A _{peak}
Polarity	Polarity independent
Isolation to	All other ports 3 kV _{rms} 50 Hz 1 min
Connection	Detachable screw terminal
Connector size	0.2 – 2.5 mm ² (AWG 24-12)
Shielded cable	Not required

* External supply current capability for proper startup

Public Switched Telephone Network (PSTN)	
Electrical specification	Public Switched Telephone Network
Data rate	300 bit/s – 33.6 kbit/s
Protocol	Bell103, Bell212, V.21, V.22, V.22Bis, V.23C, V.32, V.32Bis, V.34, V.90
Protection	Installation Fault Tolerant (up to ±60 V)
Isolation to	Power port 3 kV _{rms} 50 Hz 1 min RS-232 2 kV _{rms} 50 Hz 1 min
Connection	RJ-11C
Shielded cable	Not required

RS-232	
Electrical specification	EIA/TIA-232
Data rate	1 200 bit/s – 115.2 kbit/s
Data format	7 or 8 data bits, Odd, even or none parity, 1 or 2 stop bits; Σ 9-12 bits
Protocol	Transparent
Retiming	Yes
Transmission range	Cable length < 15 m
Isolation to	Power port 3 kV _{rms} 50 Hz 1 min RS-232 2 kV _{rms} 50 Hz 1 min
Connection	9-pin D-sub female (DCE) and Detachable screw terminal (DCE)
Connector size	Detachable screw terminal 0.2 – 2.5 mm ² (AWG 24 – 12)
Shielded cable	Not required **
Conductive housing	Isolated to all other circuits

** To minimise the risk of interference, a shielded cable is recommended when the cable is located inside 3 m boundary to the rails and connected to this port. The cable shield should be properly connected (360°) to an earthing point within 1 m from this port. This earthing point should have a low impedance connection to the conductive enclosure of the apparatus cabinet, or similar, where the unit is built-in. This conductive enclosure should be connected to the earthing system of an installation and may be directly connected to the protective earth.

RS-232 (DCE)

Position			D-sub description
D-sub	Direction*	Description	
No. 1	Out	Data Carrier Direct (DCD)	
No. 2	Out	Received Data (RD)	
No. 3	In	Transmitted Data (TD)	
No. 4	In	Data Terminal Ready (DTR)	
No. 5	–	Signal Ground (SG)	
No. 6	Out	Data Set Ready (DSR)	
No. 7	In	Request To Send (RTS)	
No. 8	Out	Clear To Send (CTS)	
No. 9	Out	Ring Indicator (RI)	

Position		
Screw terminal*	Direction*	Description
–	Not Connected	Data Carrier Direct (DCD)
No. 2	Out	Received Data (RD)
No. 1	In	Transmitted Data (TD)
No. 3	In	Data Terminal Ready (DTR)
No. 5	–	Signal Ground (SG)
No. 4	Out	Data Set Ready (DSR)

LED Indicators
(for details see next page)

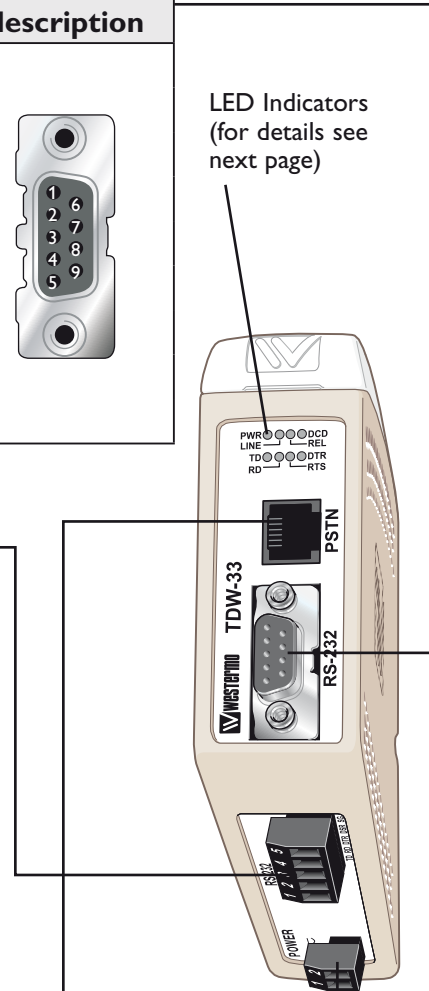

PSTN

Position			Product marking PSTN
RJ-11C	Direction*	Description	
a		Not Connected	
b		Not Connected	
c	In/Out	PSTN Transmit/ Receive	
d	In/Out	PSTN Transmit/ Receive	
e		Not Connected	
f		Not Connected	

Power LV

Position	Direction*	Description	Product marking
No. 1	In	–Voltage	
No. 2	In	+Voltage	

* Direction relative this unit.

LED Indicators

LED	Status	Description
TD Transmit data	OFF	No data
	ON / FLASH	The modem receiving data on the DTE interface
RD Receive data	OFF	No data
	ON / FLASH	The modem transmitting data on the DTE interface
RTS Request to send	OFF	RTS signal is inactive
	ON	RTS signal is active
DCD Data carrier detect	OFF	DCD signal is inactive
	ON	DCD signal is active, modem has detected a carrier or the signal is set to always ON
DTR Data terminal ready	OFF	DTR signal is inactive
	ON	DTR signal is active
REL Reliable mode	OFF	Reliable mode is OFF, direct or normal mode
	ON	Reliable mode is ON
	FLASH	Reliable mode with error correction and compression
LINE	OFF	The modem is on-hook
	ON	The modem is off-hook with a established connection
	FLASH	The modem is off-hook and negotiating
PWR Power	OFF	The modem has no power
	ON	The modem is up and running
	FLASH	The modem is in the power-on selftest

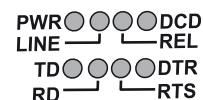

Mounting

This unit should be mounted on 35 mm DIN-rail, which is horizontally mounted inside an apparatus cabinet, or similar. Snap on mounting, see figure.

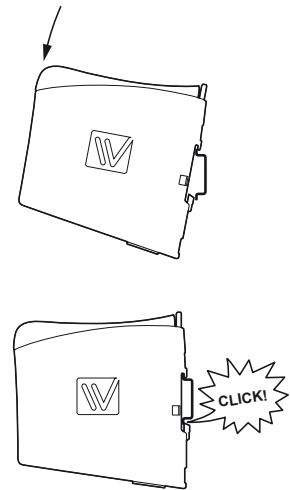

Cooling

This unit uses convection cooling. To avoid obstructing the air-flow around the unit, use the following spacing rules. Minimum spacing 25 mm (1.0 inch) above /below and 10 mm (0.4 inches) left /right the unit. Spacing is recommended for the use of unit in full operating temperature range and service life.

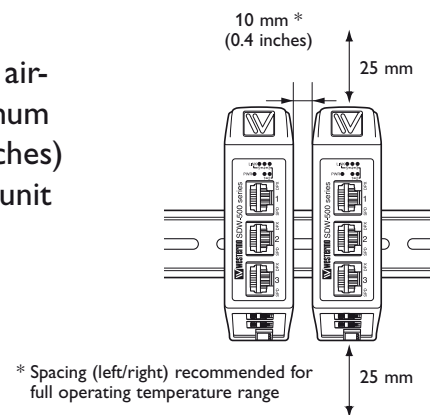

Removal

Press down the black support at the top of the unit. See figure.

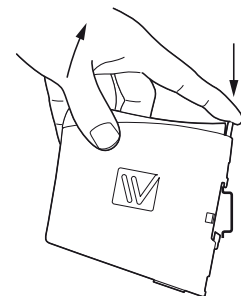

Windows configuration tool TD-Tool

The TD-Tool is a PC – application program with a graphical interface for easy configuration of the complex functions found on the enclosed CD or at the Westermo website.

Please refer to TD-Tool for a complete description of the functionality of the Windows program.

AT-Commands

Please refer to the AT Commands Interface Guide found on the enclosed CD or at the Westermo website for a complete list of all available AT-commands and a detailed description of the serial AT-command interface.

Configuration

The TDW-33 can be configured both from the local DTE interface and remotely over the PSTN network. Whether the local or remote interface is used the configuration can be made with AT-commands or with a PC-based application configuration tool. The TDW-33 can be configured from a remote modem. To configure a TDW-33 any GSM, ISDN or PSTN modem can be used.

The modem used to configure is referred as the “local modem”.

Please make sure that the remote TDW-33 is connected to the PSTN network and is powered up.

- ⌘ Connect the local modem to it's media (ISDN, PSTN or GSM)
- ⌘ Connect the PC's com-port to the DTE interface of the local modem.
- ⌘ Connect the power supply.
- ⌘ Start a terminal emulation program (i.e. Windows Hyper-Terminal).
- ⌘ Configure the local modem data rate and word format.
- ⌘ Set up a connection to the remote TDW-33 to be configured by using the normal dial command: `ATD<No><CR>`. When connected send the remote escape sequence `<++++>`. The called remote TDW-33 will acknowledge by requesting the remote password. Enter the correct password (default: no password, just return). Next; configure the remote TDW-33 using AT-commands. The password for remote configuration is defined with `AT*WRCP` – Remote configuration password.
- ⌘ Configure the parameter on the remote TDW-33 from your terminal program and save the settings with `AT&W`.
- ⌘ Hang up the connection using the `ATH` command.

Application examples

☒ TDW-33 connected to TDW-33 with DTR signal call



Configure the units

AT&F	Set the unit to factory default
AT&W	Store default settings

Set up the connection – The dialling modem

AT&Z0=nnn	Store the number of the remote modem in the dialling TDW-33
AT&S0	Set DSR signal always high (if this signal is used to trig the DTR)
AT&B1	Activates automatic DTR dialling if DTR switches from low (OFF) to high (ON)
AT&W	Save settings
Switch DTR from OFF to ON	The modem will now dial the phone number stored in the first location of the telephone number table (AT&Z0=<nnn>)

Set up the connection – The answering modem

ATA	Enter the answer command when RING comes from the network or set up AT&S0=1 to auto answer on 1 RING signal (or more than 1)
-----	--

NOTE:

If no valid DTR signal can be provided by external application, the modems DSR signal can be used to trig the transmission. Connect the DSR signal via a relay, or other potential free contact, to the DTR signal. A 10 kohm pull down resistor should also be connected between the DTR and a signal that is always low e.g. the DCD.

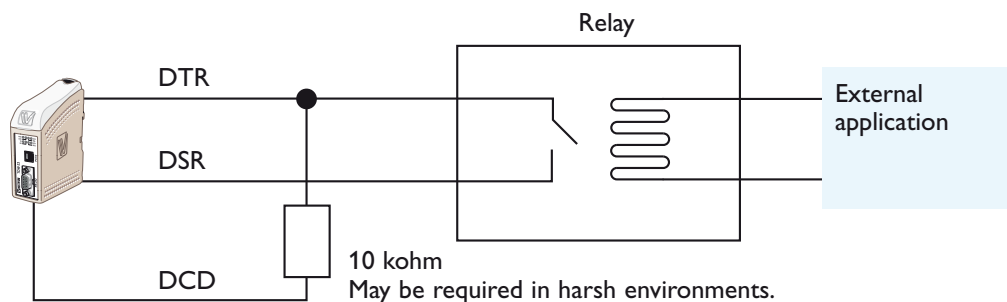

⌘ Frequently used settings for PLC-systems



Most PLC-systems and other industrial applications where modems are used require the same changes to the standard settings.

The most commonly encountered problems concern speed, parity and control signals from the connected equipment.

If this action does not solve the problem the modem's answering codes and possible echoing of commands might be the source of the difficulty.

Below follows a list of commands that might resolve the problems. The commands may of course be placed on one single command line if desired.

Configure the TDW-33 connected to the PLC

AT&F	Set the unit to factory default.
ATV0	Gives the answering codes in short format. (digits)
ATQ1	No result codes are sent on the RS-232/V.24 connection.
ATE0	Commands that are sent from the terminal/computer etc. are not echoed back to the RS-232/V.24 connection.
AT&C1	DCD will follow the carrier on the line.
AT&K0	No hand shaking.
AT&A1	Character abort option on.
AT&W	Store default settings.

⌘ TDW-33 – Secure Call-back

The TDW-33 is connected to a PLC which one want to restrict access to. The TDW-33 can support access control through the Secure Callback function. In this example password and callback to a predefined number is chosen. The modem in the calling end is here chosen to be a PSTN modem, but can be any of the PSTN, ISDN or GSM modem from the Westermo product range.

The DTE serial speed between the PLC – TDW-33 and TD-36 – PC is assumed to be 9600 8N1 but can be chosen to fit the actual system requirement.

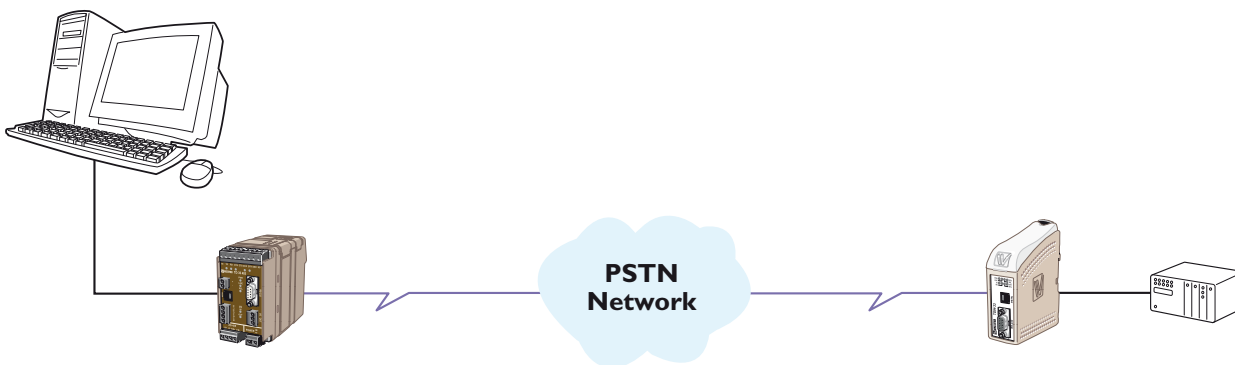

Configure the TDW-33

AT&F	Set the unit to factory default
AT+IPR=9600	DTE baudrate 9600
AT+ICF=3,4	Character framing 8 data, 1 stop, parity none
ATS0=1	Auto answer after first ring
ATQ1E0&C1&K0&A1	Suitable for PLC communication
AT&W	Store default settings
AT*WCB=4	Callback enabled, Password and callback number stored in one or more positions of wcstab
AT*WCBTAB=1,"+4670428000", "n3Y9kA6otYZu8"	Define callback number 1 When password 1 is entered number +4670428000 will be called
AT*WCBTIME=10	Define delay time between hangup and callback The TD-36 will wait 10 s after hangup to callback to allow the analogue modem to hangup

Configure the TD-36

AT&F	Set the unit to factory default
AT+IPR=9600	DTE baudrate 9600
AT+ICF=3,4	Character framing 8 data, 1 stop, parity none
ATS0=1	Auto answer after first ring
AT&W	Store default settings

Set up the connection

The dialling modem TD-36	The answering modem TDW-33	Comment
ATD0705123456	TDW-33 answers the call and requests to TDW-33	Dial the number to TDW-33
CONNECT 9600	TDW-33 verifies the password to the passwords stored and if true compare disconnects.	Operator/system at TD-36 enters Password: n3Y9kA6otYZu8
NO CARRIER	Wait 10s	The connection is broken and TDW-33 waits the programmed 10s for TDW-33 to disconnect
CONNECT 9600	TDW-33 dials +4670428000	The number programmed corresponding to the password is dialled, preferable it's the number to the TD-36
CONNECT 9600		Connection is established between the PC at TD-36 and the PLC at TDW-33

⚡ TDW-33 – Silent answering on predefined number

The TDW-33 is connected to a power meter which is remotely monitored. The TDW-33 shares the PSTN line with normal telephones which is preferred not to give a ring signal when the meter is read.

The TDW-33 is configured to answer calls on the Caller ID received, the valid numbers to answer is programmed into the TDW-33. There exists a number of standards for sending Caller ID check which standard is used by your operator. The TDW-33 supports the major implementations of Caller ID. In this example the DTMF Caller ID version is used. Note that some implementations doesn't give the possibility to make a silent answer since the Caller ID is sent between first and second ring signal.

The modem in the calling end is here chosen to be a PSTN modem, but can be any of the PSTN, ISDN or GSM modem from Westermo product range.

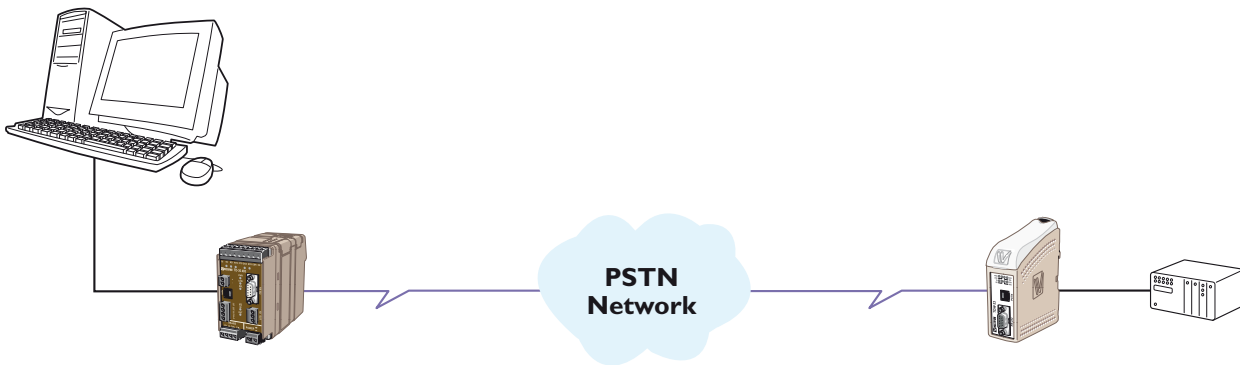

Configure the TDW-33 connected to the power meter

AT&F	Set the unit to factory default
AT+IPR=9600	DTE baudrate 9600
AT+ICF=3,4	Character framing 8 data, 1 stop, parity none
ATS0=0	No auto answer on Ring signals
ATQ1E0&C1&K0&A1	Suitable for PLC communication
AT&W	Save settings
AT*WACCTAB=1,"016428000"	
AT*WACCTAB=2,"016480250"	Set the valid A-numbers for automatic answering
AT*WCID=3,3	Set Caller ID to A-number answer with DTMF coded numbers



Westermo Teleindustri AB • SE-640 40 Stora Sundby, Sweden
Phone +46 16 42 80 00 Fax +46 16 42 80 01
E-mail: info@westermo.se
Westermo Web site: www.westermo.com

Subsidiaries

Westermo Data Communications AB
Svalgängen 1
SE-724 81 Västerås
Phone: +46 (0)16 42 80 00 • Fax: +46 (0)21 35 18 50
info.sverige@westermo.se

Westermo Data Communications Ltd
Talisman Business Centre • Duncan Road
Park Gate, Southampton • SO31 7GA
Phone: +44(0)1489 580-585 • Fax: +44(0)1489 580586
E-Mail: sales@westermo.co.uk

Westermo Data Communications GmbH
Goethestraße 67, 68753 Waghäusel
Tel.: +49(0)7254-95400-0 • Fax: +49(0)7254-95400-9
E-Mail: info@westermo.de

Westermo Data Communications S.A.R.L.
9 Chemin de Chilly 91160 CHAMPLAN
Tél : +33 1 69 10 21 00 • Fax : +33 1 69 10 21 01
E-mail : infos@westermo.fr

Westermo Data Communications Pte Ltd
2 Soon Wing Road #08-05
Soon Wing Industrial Building
Singapore 347893
Phone +65 6743 9801 • Fax +65 6745 0670
E-mail: sales@westermo.com.sg

Westermo Teleindustri AB have distributors in several countries, contact us for further information.